

# *BTI-BLIZZARD PROFILE*

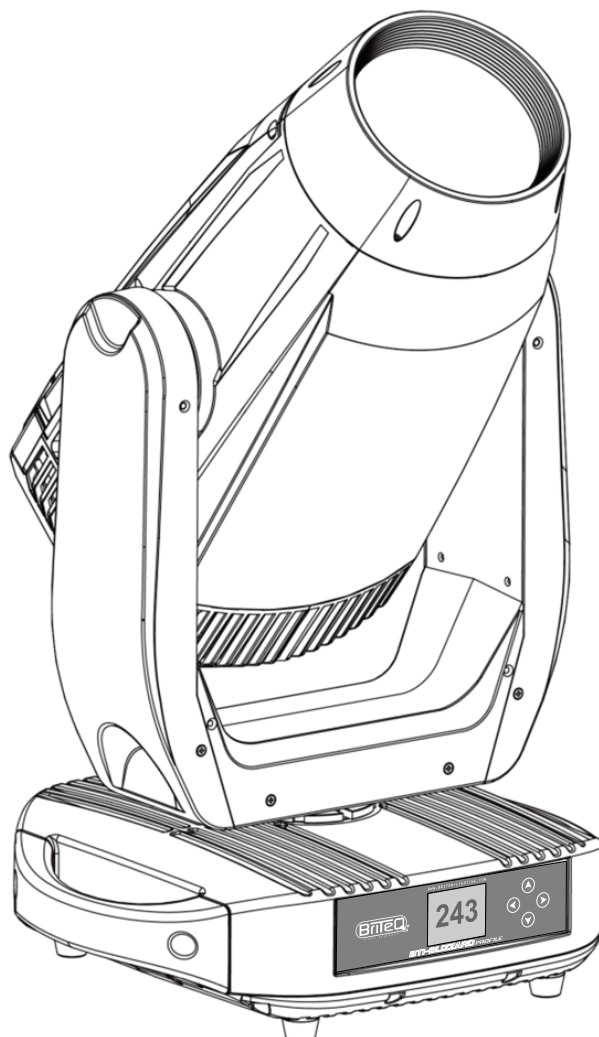

## **ENGLISH**

### **Operation Manual**

Other languages can be downloaded from:  
[WWW.BRITEQ-LIGHTING.COM](http://WWW.BRITEQ-LIGHTING.COM)



*Version: 1.0*





### **EN - DISPOSAL OF THE DEVICE**

Dispose of the unit and used batteries in an environment friendly manner according to your country regulations.

### **FR - DÉCLASSER L'APPAREIL**

Débarrassez-vous de l'appareil et des piles usagées de manière écologique Conformément aux dispositions légales de votre pays.

### **NL - VERWIJDEREN VAN HET APPARAAT**

Verwijder het toestel en de gebruikte batterijen op een milieuvriendelijke manier conform de in uw land geldende voorschriften.

### **DU - ENTSORGUNG DES GERÄTS**

Entsorgen Sie das Gerät und die Batterien auf umweltfreundliche Art und Weise gemäß den Vorschriften Ihres Landes.

### **ES - DESHACERSE DEL APARATO**

Reciclar el aparato y pilas usadas de forma ecologica conforme a las disposiciones legales de su país.

### **PT - COMO DESFAZER-SE DA UNIDADE**

Tente reciclar a unidade e as pilhas usadas respeitando o ambiente e em conformidade com as normas vigentes no seu país.

# OPERATION MANUAL

Thank you for buying this Briteq® product. To take full advantage of all possibilities and for your own safety, please read these operating instructions very carefully before you start using this unit.

## FEATURES

- BTI-BLIZZARD PROFILE is a very powerful moving profile projector
- Based on a **600W LED** light source.
- **IP65 protection and low noise operation:** perfect for both outdoor and indoor use!
- **A real allrounder** that does it all: BEAM, SPOT, WASH and FRAMING!
- Very high light output: 60.610 lux @5m (7°) - 1.713 lux @5m (50°)
- **Perfect for: concerts, events, theme parks, (outdoor) theatres, ...**
- Wide range 16bit electronic zoom, from 7° to 50° with 16bit motorized (auto) focus.
- 16bit adjustable iris: 5 → 100%
- Full featured framing module with 4 individually controlled blades and +/-60° rotation.
- CMY color system, including several color macros.
- Gradual CTO: 2700K → 6800K
- 6+1 fixed colors, including UV.
- 7+1 replaceable rotating glass gobos with fine indexing.
- 10+1 fixed static glass gobos for gobo layering.
- Nonstop rotating animation wheel with indexing.
- Bi-rotating 4 facet prism.
- 2 gradual frost filters: 1 light + 1 medium frost
- Accurate strobe with built in random, pulse and burst effects.
- Smooth 16bit dimmer with fast and slow dimming mode.
- Four dimmer curves: linear, square, inverse square, S-curve
- Fast 16bit pan/tilt movements with position correction and pan/tilt speed channel.
- Super silent fan mode for theater applications.
- Uses 35, 41 or 44 DMX channels + RDM-functionality for easy remote setup.
- Full support for Art-Net™ and sACN!
- Internal webserver for additional remote setup.
- The matrix LCD-display assures easy navigation in the different setup menus
- 5pin DMX in/outputs + RJ45 in/out + PowerCON TRUE1 compatible
- DMX in/outputs compatible with BT-XLR5TO3 kit
- Equipped with omega brackets for fast installation.

## BEFORE USE

- Before you start using this unit, please check if there is no transportation damage. Should there be any, do not use the device and consult your dealer first.
- **Important:** This device left our factory in perfect condition and well packaged. It is necessary for the user to strictly follow the safety instructions and warnings in this user manual. Any damage caused by mishandling is not subject to warranty. The dealer will not accept responsibility for any resulting defects or problems caused by disregarding this user manual.
- Keep this booklet in a safe place for future consultation. If you sell the fixture, be sure to add this user manual.

### Check the contents:

Check that the carton contains the following items:

- BTI-BLIZZARD PROFILE
- PowerCON® TRUE-1 compatible mains cable
- 2 BriteQ omega brackets BIG
- Safety cable
- Operating instructions

## SAFETY INSTRUCTIONS



**CAUTION**  
RISK OF ELECTRIC SHOCK  
DO NOT OPEN



**CAUTION:** To reduce the risk of electric shock, do not remove the top cover. No user-serviceable parts inside. Refer servicing to qualified service personnel only.



The lightning flash with arrowhead symbol within the equilateral triangle is intended to alert the user or the presence of un-insulated "dangerous voltage" within the product's enclosure that may be of sufficient magnitude to constitute a risk of electric shock.



The exclamation point within the equilateral triangle is intended to alert the user to the presence of important operation and maintenance (servicing) instructions in the literature accompanying this appliance.

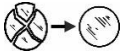

This symbol means: repair any broken lenses!



This symbol means: Do not stare at the operating light source



This symbol means: Read instructions



This symbol determines: the minimum distance from lighted objects. The minimum distance between light-output and the illuminated surface must be more than 0.2 meters

- To protect the environment, please try to recycle the packing material as much as possible.
- A new light effect sometimes causes some unwanted smoke and/or smell. This is normal and disappears after some minutes.
- To prevent fire or shock hazard, do not expose this appliance to rain or moisture.
- To avoid condensation to be formed inside, allow the unit to adapt to the surrounding temperatures when bringing it into a warm room after transport. Condensation sometimes prevents the unit from working at full performance or may even cause damages.
- Don't place metal objects or spill liquid inside the unit. Electric shock or malfunction may result. If a foreign object enters the unit, immediately disconnect the mains power.
- Locate the fixture in a well-ventilated spot, away from any flammable materials and/or liquids. The fixture must be fixed at least 20cm from surrounding walls.
- Don't cover any ventilation openings as this may result in overheating.
- Prevent use in dusty environments and clean the unit regularly.
- Keep the unit away from children.
- Inexperienced persons should not operate this device.
- Maximum safe ambient temperature is 40°C. Don't use this unit at higher ambient temperatures.
- The units' surface temperature may reach up to 85°C. Don't touch the housing with bare hands during its operation.
- Make sure the area below the installation place is free from unwanted persons during rigging, de-rigging and servicing.
- Allow the device about 10 minutes to cool down before replacing the bulb or start servicing.
- Always unplug the unit when it is not used for a longer time or before replacing the bulb or start servicing.
- The electrical installation should be carried out by qualified personal only, according to the regulations for electrical and mechanical safety in your country.
- Check that the available voltage is not higher than the one stated on the rear panel of the unit.
- The power cord should always be in perfect condition. Switch the unit immediately off when the power cord is squashed or damaged. It must be replaced by the manufacturer, its service agent or similarly qualified persons in order to avoid a hazard.
- Never let the power-cord come into contact with other cables!
- This fixture must be earthed to comply with safety regulations.
- Don't connect the unit to any dimmer pack.
- Always use an appropriate and certified safety cable when installing the unit.
- To prevent electric shock, do not open the cover. Apart from the lamp and mains fuse there are no user serviceable parts inside.
- Never repair a fuse or bypass the fuse holder. Always replace a damaged fuse with a fuse of the same type and electrical specifications!
- In the event of serious operating problems, stop using the fixture and contact your dealer immediately.
- The housing and the lenses must be replaced if they are visibly damaged.
- Please use the original packing when the device is to be transported.
- Due to safety reasons it is prohibited to make unauthorized modifications to the unit.

**Important:** Never look directly into the light source! Don't use the effect in the presence of persons suffering from epilepsy.

## DESCRIPTION:

### REAR PANEL:

1. Seetronic IP65 power input
2. Fuse slot (20x5mm, T6,3A / 250V)
3. Network in/output for ArtNet & sACN
4. XLR output 5-pin
5. XLR input 5-pin

PS: 4+5 can be changed to XLR-3pin with an optional BT-XLR5TO3 COMBIKIT

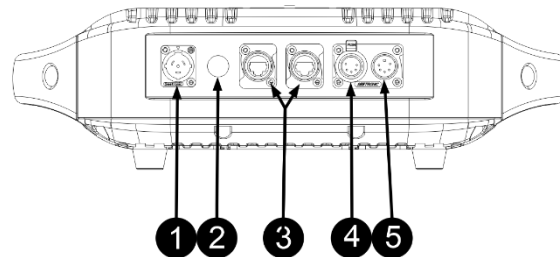

### FRONT PANEL:

6. LCD screen
7. Left button – Used to go back in the menu. Press this ◀-button during 5seconds to wake up the display when it is in sleep mode (dark)!
8. Right button – used to confirm a menu item
9. Up button – Used to go up in the menu or increase the selected value.
10. Down button – Used to go down in the menu or decrease the selected value.

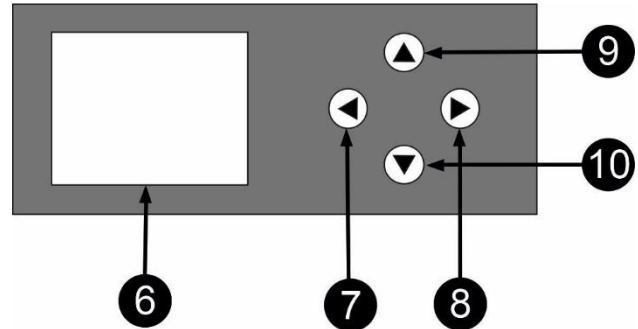

## OVERHEAD RIGGING

- **Important:** The installation must be carried out by qualified service personal only. Improper installation can result in serious injuries and/or damage to property. Overhead rigging requires extensive experience! Working load limits should be respected, certified installation materials should be used, the installed device should be inspected regularly for safety.
- Make sure the area below the installation place is free from unwanted persons during rigging, de-rigging and servicing.
- Locate the fixture in a well-ventilated spot, far away from any flammable materials and/or liquids. The fixture must be fixed **at least 50cm** from surrounding walls.
- The device should be installed out of reach of people and outside areas where persons may walk by or be seated.
- Before rigging make sure that the installation area can hold a minimum point load of 10times the device's weight.
- Always use a certified safety cable that can hold 12 times the weight of the device when installing the unit. This secondary safety attachment should be installed in a way that no part of the installation can drop more than 20cm if the main attachment fails.
- The device should be well fixed; a free-swinging mounting is dangerous and may not be considered!
- Don't cover any ventilation openings as this may result in overheating.
- The operator must make sure that the safety-relating and machine-technical installations are approved by an expert before using them for the first time. The installations should be inspected every year by a skilled person to be sure that safety is still optimal.
- Fix the Truss hooks to the optional omega brackets with screw and locking nut.
- Fasten the omega brackets on the bottom of the base by inserting quick-lock fasteners into the holes of the base and tighten fully clockwise. (you should hear or feel a 'click')

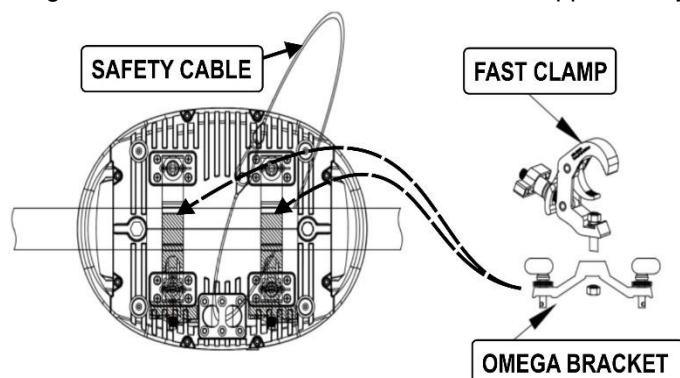

# ELECTRICAL INSTALLATION

**⚠ Important:** The electrical installation should be carried out by qualified personal only, according to the regulations for electrical and mechanical safety in your country.

## Electrical installation for two or more units in ArtNet/sACN-mode:

Art-Net is nothing more than a protocol for transmitting DMX512 over an Ethernet network, developed by Artistic Licence Engineering (UK) Ltd. Thanks to the much bigger bandwidth it is possible to send more than 256 DMX-universes in one time.

This projector can be connected in such Ethernet network using routers, switches etc. The network topology is exactly the same as for a normal PC-network. However, IP-addresses cannot be obtained via DHCP: see the explanations in the chapter “setup menu” on how to manually setup the IP-address, Net Mask and choose the desired DMX-universe. Also the sACN protocol is supported.

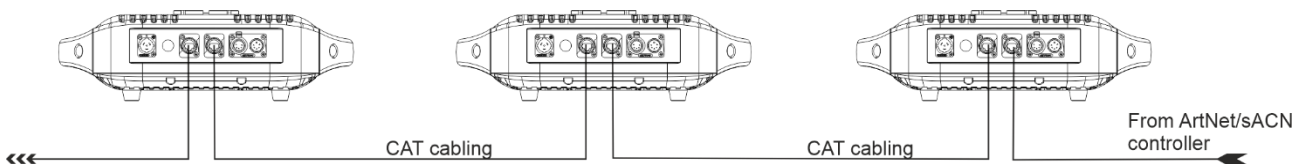

**IMPORTANT NOTE:** this projector has both Ethernet input and output so you can daisy chain several units. However, the number of units in one chain should be limited to ±10 units to avoid unwanted signal delays. In bigger installations you should use the “STAR-topology” using Ethernet switches (or a combination of both).

## Electrical installation for two or more units in ArtNet to DMX-mode:

- Internally the selected DMX-universe is treated as a normal DMX-signal so further setup of the DMX-address, channel mode etc. should be done as usual.
- Thanks to the internal Art-Net node all 512 channels of the selected DMX-universe are automatically converted from Art-Net to the DMX-output: they can be used to control other DMX-equipment:

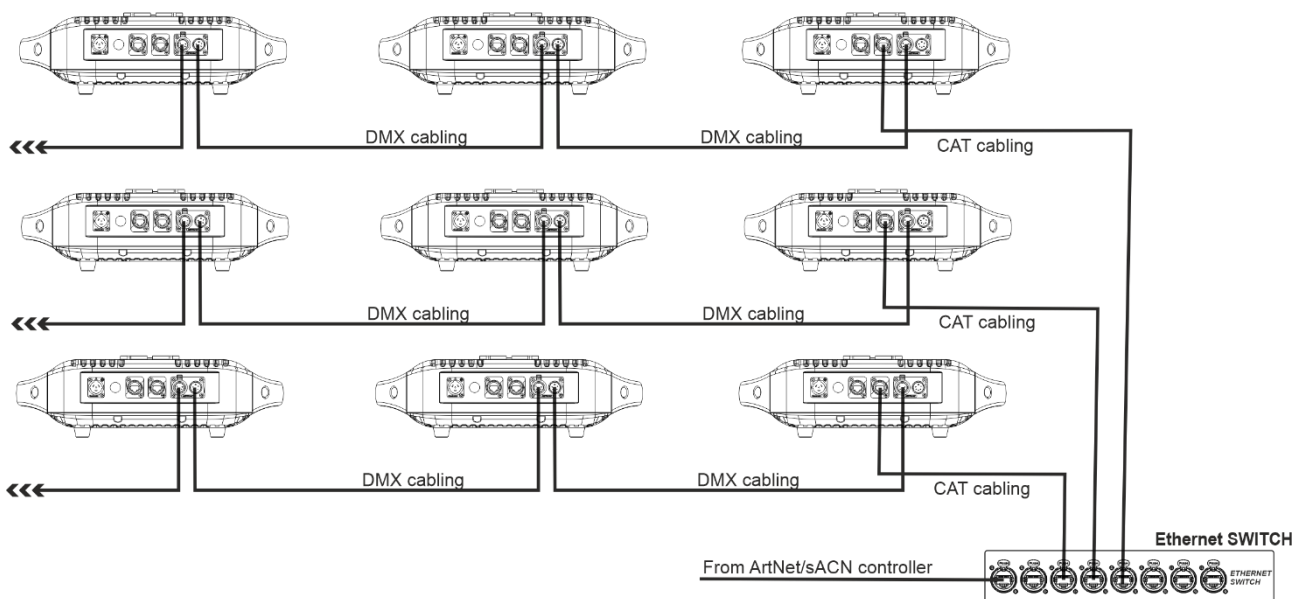

## Electrical installation for two or more units in DMX-mode:

- The DMX-protocol is a widely used high speed signal to control intelligent light equipment. You need to “daisy chain” your DMX controller and all the connected units with a good quality balanced cable.
- Both XLR-3pin and XLR-5pin connectors are used, however XLR-3pin is more popular because these cables are compatible with balanced audio cables.  
 Pin layout XLR-3pin: Pin1 = GND ~ Pin2 = Negative signal (-) ~ Pin3 = Positive signal (+)  
 Pin layout XLR-5pin: Pin1 = GND ~ Pin2 = Negative signal (-) ~ Pin3 = Positive signal (+) ~ Pins4+5 not used.
- To prevent strange behavior on the DMX units, due to interferences, you must use a 90Ω to 120Ω terminator at the end of the chain. Never use Y-splitter cables, this simply won't work!
- Make sure that all units are connected to the mains.

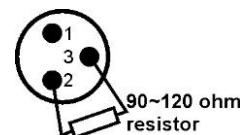

- Each unit in the chain needs to have its proper starting address so it knows which commands from the controller it has to decode. In the next section you will learn how to set the DMX addresses.

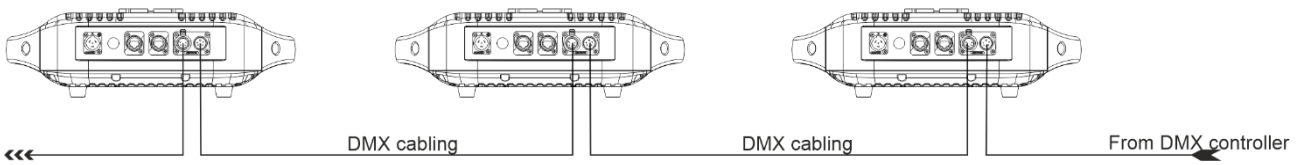

**Wiring of the DMX connectors:**

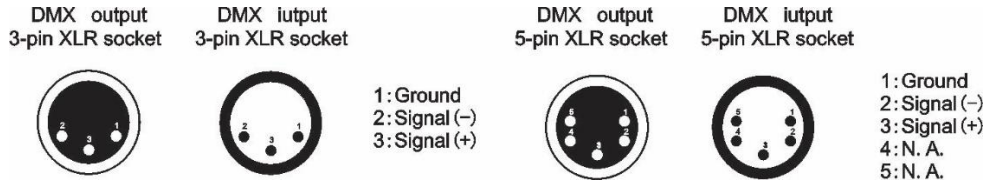

**OPERATING INSTRUCTIONS**

- In the event of serious operating problems, stop using the fixture and contact your dealer immediately.
- **Important:** Never look directly into the light source! Don't use the effect in the presence of persons suffering from epilepsy.

**SETTING MENU**

Press the RIGHT button on the display to open the setup menu. Use the UP/DOWN, LEFT and RIGHT buttons to navigate:

Level 0	Level 1	Level 2	Level 3	Defaults	
Address	001-512			001	
Person	Basic			Standard	
	Standard				
	Extended				
Runmode	DMX512			DMX512	
	Artnet				
	Artnet to DMX				
	sACN				
	Auto				
	Custom 1				
	Custom 2				
Option	Pan invert	On/Off		Off	
	Tilt invert	on/Off		Off	
	Perform		Studio		Live
			Power		
			Live		
	Blackout			On/Off	Off
	Dimmer		Dim 4		Off
			Dim 3		
			Dim 2		
			Dim 1		
	LED PWM		Off		1200Hz
			1200Hz		
			2400Hz		
			4000Hz		
			6000Hz		
DMX error	Freeze/Blackout			Freeze	
Display Time		On		30s	
		30s			
		1min			
Display Lock			2min	Off	
			On/Off	Off	

	<b>Load Para</b>		Yes/No	No
	<b>Setting</b>	Recovery		
		Clean Edit 1		
		Clean Edit 2		
		WDMX hide	Yes/No	Yes
	<b>Network</b>	Net switch	On/Off	Off
		Universe	000-255	0
		IP mode	Default IP	Default IP
			Custom IP	xxx.xxx.xxx.xxx
	<b>PT Encoder</b>		On/Off	On
	<b>WDMX Pair</b>		Pair/Unpair	No
	<b>Signal</b>	Only XLRDMX		/
		XLRDMX first		
		Only WDMX		
		WDMX first		
		WDMX to XLR DMX		
<b>Edit</b>	<b>Edit1</b>	Step 1		
		Step...		
		Step 30		
	<b>Edit 2</b>	Step 1		
		Step...		
		Step 30		
<b>Manual</b>	<b>Auto test</b>			
	<b>Channel</b>			
	<b>Debug hide</b>	Yes/No		
	<b>Reset</b>	All reset		
		PT Reset		
		Color Sys		
Other				
<b>Info</b>	<b>Fixture hours</b>		xxxxh	
	<b>LED use hours</b>		xxxxh	
	<b>Temperature</b>		xx°C	
			xx°C	
	<b>Version</b>		V x.xx	
	<b>Network</b>		...	
	<b>RDM</b>		...	
<b>System error</b>		...		
<b>Service</b>	<b>Pan</b>		-127 to +127	
	<b>Tilt</b>		-127 to +127	
	<b>Color</b>		-127 to +127	
	...		-127 to +127	

**Address**

Used to set the DMX-starting address.

- Press the right button to open the menu. (Enter the password if prompted)
- Press the up/down buttons to select the **ADDRESS** option and hit the right button to select.
- Use the up/down buttons to select the correct DMX address
- Press the right button to confirm.

**Person**

Used to set the channel mode of the unit

- Press the right button to open the menu. (Enter the password if prompted)
- Press the up/down buttons to select the **PERSON** option and hit the right button to select.
- Use the up/down buttons to select the correct DMX address
  - **Basic:** 35 Channels
  - **Standard:** 41 Channels
  - **Extended:** 44 Channels
- Press the right button to confirm.



**Runmode****Used to set the channel mode of the unit**

- Press the right button to open the menu. (Enter the password if prompted)
- Press the up/down buttons to select the **RUNMODE** option and hit the right button to select.
- Use the up/down buttons to select the correct DMX address
  - **DMX512** : Fixture reacts to DMX
  - **ArtNet**: Fixture reacts to ArtNet
  - **ArtNet to DMX**: Fixture acts as a ArtNet node and will transform ArtNet to DMX on its output
  - **sACN**: Fixture reacts to sACN
  - **AUTO** : Fixture steps automatically through pre-programmed steps
  - **Custom1/Custom2** : Fixture steps automatically through user-programmed steps
- Press the right button to confirm.

**Option****Menu with functions related to the overall settings of the fixture****PAN INVERT****Used to invert the pan movement**

- Press the right button to open the menu. (Enter the password if prompted)
- Press the up/down buttons to select **OPTION** and hit the right button to select.
- Press the up/down buttons to select the **PAN INVERT** option and hit the right button to select.
- Use the up/down buttons to select **OFF/ON**
- Press the right button to confirm.

**TILT INVERT****Used to invert the tilt movement**

- Press the right button to open the menu. (Enter the password if prompted)
- Press the up/down buttons to select **OPTION** and hit the right button to select
- Press the up/down buttons to select the **TILT INVERT** option and hit the right button to select.
- Use the up/down buttons to select **OFF/ON**
- Press the right button to confirm.

**PERFORM****Used to select the cooling mode**

- Press the right button to open the menu. (Enter the password if prompted)
- Press the up/down buttons to select **OPTION** and hit the right button to select
- Press the up/down buttons to select the **PERFORM** option and hit the right button to select.
- Use the up/down buttons to select the correct mode
  - **STUDIO**: Silent mode, perfect for use in theatres. (output is slightly lower to assure good cooling)
  - **POWER**: Full power mode, perfect for use on rock festival stages (best cooling + light output)
  - **LIVE**: Temperature controlled mode, standard mode. (best balance between cooling + light output)
- Press the Right button to confirm.

**BLACKOUT****Used to select the move-in-dark function**

- Press the right button to open the menu. (Enter the password if prompted)
- Press the up/down buttons to select **OPTION** and hit the right button to select
- Press the up/down buttons to select the **BLACKOUT** option and hit the right button to select.
- Use the up/down buttons to select **ON/OFF**
- Press the right button to confirm.

**DIMMER****Used to select the dimmer fade out speed**

- Press the right button to open the menu. (Enter the password if prompted)
- Press the up/down buttons to select **OPTION** and hit the right button to select
- Press the up/down buttons to select the **DIMMER** option and hit the right button to select.
- Use the up/down buttons to select:
  - **DIM4**: 0.6s fade out
  - **DIM3**: 0.5s fade out
  - **DIM2**: 0.4s fade out
  - **DIM1**: 0.3s fade out

- **OFF:** No fade time on Dimmer (LED behavior)
- Press the right button to confirm.

### LED PWM

#### Used to select the PWM frequency of the LED

- Press the right button to open the menu. (Enter the password if prompted)
- Press the up/down buttons to select **OPTION** and hit the right button to select
- Press the up/down buttons to select the **LED PWM** option and hit the right button to select.
- Use the up/down buttons to select the correct frequency
- Press the right button to confirm.

### DMX ERROR

#### Used to select the behavior of the fixture when no DMX is received

- Press the right button to open the menu. (Enter the password if prompted)
- Press the up/down buttons to select **OPTION** and hit the right button to select
- Press the up/down buttons to select the **DMX ERROR** option and hit the right button to select.
- Use the up/down buttons to select the correct mode
  - **Freeze:** Fixture holds last received values
  - **Black:** Fixture turns the LED OFF and turns to a base position
- Press the Right button to confirm.

### DISPLAY TIME

#### Used to select the ON time of the display

- Press the right button to open the menu. (Enter the password if prompted)
- Press the up/down buttons to select **OPTION** and hit the right button to select
- Press the up/down buttons to select the **DISPLAY TIME** option and hit the right button to select.
- Use the up/down buttons to select the desired setting
- Press the right button to confirm.

**IMPORTANT NOTE:** when the display turns dark, press the ◀-button (left button) during 5 seconds!

### MENU LOCK

#### Used to lock the menu

- Press the right button to open the menu. (Enter the password if prompted)
- Press the up/down buttons to select **OPTION** and hit the right button to select
- Press the up/down buttons to select the **MENU LOCK** option and hit the right button to select.
- Use the up/down buttons to select **ON/OFF**
- Press the right button to confirm.

**Note:** press the **UP/DOWN/UP/DOWN/RIGHT** buttons successively to unlock the menu when it is locked.

### LOAD

#### Used to share menu settings over DMX

- Press the right button to open the menu. (Enter the password if prompted)
- Press the up/down buttons to select **OPTION** and hit the right button to select
- Press the up/down buttons to select the **LOAD PARA** option and hit the right button to select.
- Use the up/down buttons to select
  - **ON:** Download data off the DMX line
  - **OFF:** Share data on the DMX line
- Press the right button to confirm.

### SETTING

#### Used to create and restore settings

- Press the right button to open the menu. (Enter the password if prompted)
- Press the up/down buttons to select **OPTION** and hit the right button to select
- Press the up/down buttons to select the **SETTING** option and hit the right button to select.
- Use the up/down buttons to select
  - **Recovery:** restore factory settings
  - **Clean Edit 1/2:** Clear user program 1 or 2
  - **WDMX Hide:** (Un)Hide WDMX settings
- Press the right button to confirm.

**PT ENCODER**

**Used to enable/disable the Pan/Tilt feedback sensor**

- Press the right button to open the menu. (Enter the password if prompted)
- Press the up/down buttons to select **OPTION** and hit the right button to select
- Press the up/down buttons to select the **PT ENCODER** option and hit the right button to select.
- Use the up/down buttons to select **ON/OFF**
- Press the right button to confirm.

**WDMX RESET**

**Used to Pair/Unpair the WDMX**

- Press the right button to open the menu. (Enter the password if prompted)
- Press the up/down buttons to select **OPTION** and hit the right button to select
- Unhide the WDMX settings as explained in the **SETTING** option
- Press the up/down buttons to select the **WDMX RESET** option and hit the right button to select.
- Use the up/down buttons to select
  - **YES:** Enables WMDX pairing mode
  - **NO:** Reset current connection
- Press the right button to confirm.

**SIGNAL**

**Used to enable WDMX operation**

- Press the right button to open the menu. (Enter the password if prompted)
- Press the up/down buttons to select **OPTION** and hit the right button to select
- Unhide the WDMX settings as explained in the **SETTING** option
- Press the up/down buttons to select the **SIGNAL** option and hit the right button to select.
- Use the up/down buttons to select
  - **ONLY XLRDMX:** WDMX disabled
  - **XLRDMX First:** Can receive XLRDMX and WDMX but prioritize XLRDMX
  - **ONLY WDMX:** Receive only WDMX
  - **WDMX First:** Can receive XLRDMX and WDMX but prioritize WDMX
  - **WDMX TO XLR DMX:** WDMX enabled and DMX output on XLR output
- Press the right button to confirm.

**EDIT**

**Used to edit custom patterns for standalone use**

- Press the right button to open the menu. (Enter the password if prompted)
- Press the up/down buttons to select the **EDIT** option and hit the right button to select.
- Use the up/down buttons to select the program to edit (**EDIT1** or **EDIT2**)
- Press the Right button to set the values for step 1
  - **Pan**
  - **Tilt**
  - **...:** Set the desired value for the channel
  - **Time:** duration of the step between 0-25s
  - **Use:** Activate/Disable step
- Press the right button to confirm.
- Continue for step 2-30

**MANUAL**

**Menu with functions related to the overall settings of the fixture**

**CHANNEL**

**Used to test individual channels of the fixture**

- Press the right button to open the menu. (Enter the password if prompted)
- Press the up/down buttons to select the **MANUAL** option and hit the right button to select.
- Press the up/down buttons to select the **CHANNEL** option and hit the right button to select.
- Press the up/down buttons to select the desired channel and hit the right button to select the channel
- Press the Up/Down buttons to change the value of the channel.
- Press the Left button to exit the channel.

**DEBUG HIDE****Factory testing mode.**

This disables all motors, motors can only be activated again with a reset.

**RESET****Used to manually reset the fixture**

- Press the right button to open the menu. (Enter the password if prompted)
- Press the up/down buttons to select the **MANUAL** option and hit the right button to select.
- Press the up/down buttons to select the **RESET** option and hit the right button to select.
- Use the up/down buttons to select
  - **ALL RESET:** Reset the entire fixture
  - **PT RESET:** Reset the pan/tilt motors
  - **OTHER RESET:** Reset the Zoom motor
- Press the right button to confirm.

**INFO****Menu with Information about the fixture****FIXTURE**

Displays the total active hours of the fixture

**LED**

Displays the total active hours of the LED

**TEMPERATURE**

Displays the temperature of the LED unit

**VERSION**

Displays the current fixture firmware version

**Network**

Displays the current networking information

**RDM**

Displays the RDM information of the fixture

RDM UID: 0x21220054\*\*\*\* (\*\*\*\* = unique number)

RDM Label: BTI-BLIZZARD PROFILE

**SYSTEM ERROR**

Displays possible system errors

**SERVICE****Used to calibrate the base pan/tilt position**

- Press the right button to open the menu. (Enter the password if prompted)
- Press the up/down buttons to select the **SERVICE** option and hit the right button to select.
- Enter the password (Up-Down-Up-Down)
- Use the up/down buttons to select the function to calibrate and hit the Right button to select
- Use the Up: Down buttons to edit the base value (-127 to +127) and hit the Right button to confirm

## **DMX CHANNELS**

The unit is equipped with 5 different DMX modes:

- **Basic:** 35 Channels
- **Standard:** 41 Channels
- **Extended:** 44 Channels

### **Reduced DMX Chart**

<b>Basic</b>	<b>Standard</b>	<b>Extended</b>	<b>Function</b>
1	1	1	Pan
-	2	2	Pan fine
2	3	3	Tilt
-	4	4	Tilt fine
3	5	5	P/T Speed
4	6	6	Cyan
5	7	7	Magenta
6	8	8	Yellow
7	9	9	CTO
8	10	10	Color macro
9	11	11	CMY Speed
10	12	12	Color Wheel
-	-	13	Color Wh fine
11	13	14	Gobo 1
12	14	15	Gobo rotation
	15	16	Gobo rot fine
13	16	17	Gobo 2
14	17	18	Animation wheel
15	18	19	Animation Rotation
16	19	20	Prism
17	20	21	Frost 1
18	21	22	Frost 2
19	22	23	Iris
-	-	24	Iris fine
20	23	25	Zoom
-	24	26	Zoom fine
21	25	27	Focus
-	26	28	Focus fine
22	27	29	Auto focus
23	28	30	Auto focus fine
24	29	31	Framing 1 left
25	30	32	Framing 1 right
26	31	33	Framing 2 left
27	32	34	Framing 2 right
28	33	35	Framing 3 left
29	34	36	Framing 3 right
30	35	37	Framing 4 left
31	36	38	Framing 4 right
32	37	39	Framing rotation
-	-	40	Framing rot fine
33	38	41	Dimmer
-	39	42	Dimmer fine
34	40	43	Strobe
35	41	44	Control

**Full DMX Chart**

Basic	Standard	Extended	Function	Values	Default	
1	1	1	Pan	000-255	128/32768	
-	2	2	Pan fine	000-255		
2	3	3	Tilt	000-255	128/32768	
-	4	4	Tilt fine	000-255		
3	5	5	P/T Speed	000-255	0	
4	6	6	Cyan	000-255	0	
5	7	7	Magenta	000-255	0	
6	8	8	Yellow	000-255	0	
7	9	9	CTO	000-255	0	
8	10	10	Color macro	000-019	Disabled	0
				020-021	3000K	
				022-023	3200K	
				024-025	3500K	
				026-027	4000K	
				028-029	4500K	
				030-031	5000K	
				032-033	5400K	
				034-035	5600K	
				036-037	6000K	
				038-039	6500K	
				040-041	6800K	
				042-043	L106	
				044-045	L194	
				046-047	L019	
				048-049	R08	
				050-051	L213	
				052-053	R80	
054-055	L202					
056-057	L328					
058-059	R3314					
060-061	L101					
062-063	L768					
064-255	Fade R-G-B-R					
9	11	11	CMY Speed	000-255	0	
10	12	12	Color Wheel	000-007	Open	0
				008-015	Color 1	
				016-023	Color 2	
				024-031	Color 3	
				032-039	Color 4	
				040-047	Color 5	
				048-055	Color 6	
				056-191	Index	
				192-222	CW Spin Fast-Slow	
				223-224	Stop	
				225-255	CCW Spin Slow-Fast	
-	-	13	Color Wh fine	000-255		
11	13	14	Gobo 1	000-010	Open	0
				011-018	Gobo 1	
				019-026	Gobo 2	
				027-034	Gobo 3	
				035-042	Gobo 4	
				043-050	Gobo 5	
				051-058	Gobo 6	
				059-066	Gobo 7	
				067-074	Shake Gobo 1	
				075-082	Shake Gobo 2	
				083-090	Shake Gobo 3	
091-098	Shake Gobo 4					

				099-106	Shake Gobo 5	
				107-114	Shake Gobo 6	
				115-122	Shake Gobo 7	
				123-127	Open	
				128-190	CW Spin Fast-Slow	
				191-192	Stop	
				193-255	CCW Spin Slow-Fast	
<b>12</b>	<b>14</b>	<b>15</b>	<b>Gobo rotation</b>	000-120	Index	0
				121-125	No function	
				126-165	Rotation shake 0-100	
				166-170	No function	
				171-210	CW Rotation Fast-Slow	
				211-215	Stop	
				216-255	CCW Rotation Slow-Fast	
	<b>15</b>	<b>16</b>	<b>Gobo rot fine</b>	000-255		
<b>13</b>	<b>16</b>	<b>17</b>	<b>Gobo 2</b>	000-010	Open	0
				011-015	Gobo 1	
				016-020	Gobo 2	
				021-025	Gobo 3	
				026-030	Gobo 4	
				031-035	Gobo 5	
				036-040	Gobo 6	
				041-045	Gobo 7	
				046-050	Gobo 8	
				051-055	Gobo 9	
				056-060	Gobo 10	
				061-065	Shake Gobo 1	
				066-070	Shake Gobo 2	
				071-075	Shake Gobo 3	
				076-080	Shake Gobo 4	
				081-085	Shake Gobo 5	
				086-090	Shake Gobo 6	
				091-095	Shake Gobo 7	
				096-100	Shake Gobo 8	
				101-105	Shake Gobo 9	
				106-110	Shake Gobo 10	
				111-127	Open	
				128-190	CW Spin Fast-Slow	
				191-192	Stop	
				193-255	CCW Spin Slow-Fast	
<b>14</b>	<b>17</b>	<b>18</b>	<b>Animation wheel</b>	000-255		0
<b>15</b>	<b>18</b>	<b>19</b>	<b>Animation Rotation</b>	000-010	No rotation	0
				011-127	CW Rotation Slow-Fast	
				128-138	Stop	
				139-255	CCW Rotation Fast-Slow	
<b>16</b>	<b>19</b>	<b>20</b>	<b>Prism</b>	000-010	Open	
				011-145	Index	
				146-150	No function	
				151-200	CW Rotation Fast-Slow	
				201-205	Stop	
				206-255	CCW Rotation Slow-Fast	
<b>17</b>	<b>20</b>	<b>21</b>	<b>Frost 1</b>	000-255		
<b>18</b>	<b>21</b>	<b>22</b>	<b>Frost 2</b>	000-255		
<b>19</b>	<b>22</b>	<b>23</b>	<b>Iris</b>	000-127	Open-Close	0
				128-130	Closed	
				131-171	Iris pulse	
				172-211	Iris Close pulse	
				212-251	Iris Open pulse	
				252-255	Closed	
-	-	<b>24</b>	<b>Iris fine</b>	000-255		
<b>20</b>	<b>23</b>	<b>25</b>	<b>Zoom</b>	000-255		32768

-	24	26	Zoom fine	000-255		
21	25	27	Focus	000-255		32768
-	26	28	Focus fine	000-255		
22	27	29	Auto focus	000-012	Disabled	0
				013-039	5m	
				040-066	7m	
				067-093	9m	
				094-120	11m	
				121-147	13m	
				148-174	15m	
				175-201	17m	
				202-228	19m	
229-255	21m					
23	28	30	Auto focus fine	000-255		
24	29	31	Framing 1 left	000-255		0
25	30	32	Framing 1 right	000-255		0
26	31	33	Framing 2 left	000-255		0
27	32	34	Framing 2 right	000-255		0
28	33	35	Framing 3 left	000-255		0
29	34	36	Framing 3 right	000-255		0
30	35	37	Framing 4 left	000-255		0
31	36	38	Framing 4 right	000-255		0
32	37	39	Framing rotation	000-255		0
-	-	40	Framing rot fine	000-255		0
33	38	41	Dimmer	000-255		0
-	39	42	Dimmer fine	000-255		
34	40	43	Strobe	000-009	Open	0
				010-099	Strobe	
				100-109	Open	
				110-179	Lightning strobe	
				180-189	Open	
				190-255	Random strobe	
35	41	44	Control	000-010	No function	0
				011-020	BO P/T enabled	
				021-030	BO P/T disabled	
				031-040	Pan invert	
				041-050	Tilt invert	
				051-060	P/T revert Off	
				061-070	Studio	
				071-080	Power	
				081-090	Live	
				091-100	Dim 4	
				101-110	Dim 3	
				111-120	Dim 2	
				121-130	Dim 1	
				131-140	Dim 0	
				141-150	1200Hz	
				151-160	2400Hz	
				161-170	4000Hz	
				171-180	6000Hz	
				181-190	25000Hz	
				191-200	All reset	
201-210	P/T reset					
211-220	Color reset					
221-230	Focus/Zoom reset					
231-255	Framing reset					



## MAINTENANCE

- Make sure the area below the installation place is free from unwanted persons during servicing.
- Switch off the unit, unplug the mains cable and wait until the unit has been cooled down.

**During inspection the following points should be checked:**

- All screws used for installing the device and any of its parts should be tightly fastened and may not be corroded.
- Housings, fixations and installations spots (ceiling, truss, suspensions) should be totally free from any deformation.
- When an optical lens is visibly damaged due to cracks or deep scratches, it must be replaced.
- The mains cables must be in impeccable condition and should be replaced immediately when even a small problem is detected.
- To protect the device from overheat the cooling fans (if any) and ventilation openings should be cleaned monthly.
- The interior of the device should be cleaned annually using a vacuum cleaner or air-jet.
- The cleaning of internal and external optical lenses and/or mirrors must be carried out periodically to optimize light output. Cleaning frequency depends on the environment in which the fixture operates: damp, smoky or particularly dirty surroundings can cause greater accumulation of dirt on the unit's optics.
  - Clean with a soft cloth using normal glass cleaning products.
  - Always dry the parts carefully.
  - Clean the external optics at least once every 30 days.

## SPECIFICATIONS

This device carries the prescribed CE marking. It was tested for this purpose in a specialized CE lab and fully complies with all currently valid European and national standards. The corresponding CE conformity declarations can be found on the product page of this product on our website.

<b>Mains Input:</b>	AC 100~240V, 50/60Hz
<b>Power consumption:</b>	750Watt (max.)
<b>IP-rating:</b>	IP65
<b>Operation Temperature:</b>	-20°C → +45°C
<b>Fuse:</b>	6,3A / 250V slow.
<b>Optional backup battery:</b>	model 18650 * 3,7V Li-ion
<b>Sound Control:</b>	none
<b>DMX connections:</b>	5pin XLR IN/OUT, RDM compatible, (W-DMX optional)
<b>Movement:</b>	Pan: 540° Tilt: 210°
<b>Beam angle:</b>	5°→ 48°
<b>DMX channels used:</b>	35, 41 and 44 Channels
<b>Lamp:</b>	600W LED
<b>Size:</b>	416 x 364 x 728 mm
<b>Weight:</b>	38 kg

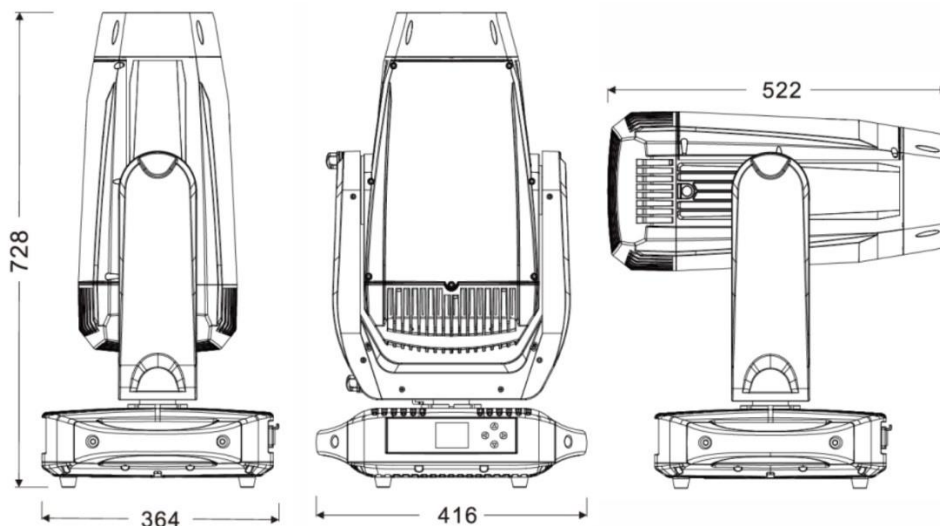

### LUX CHART

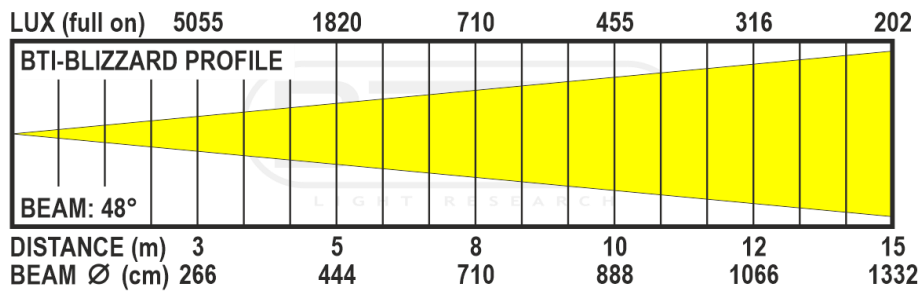
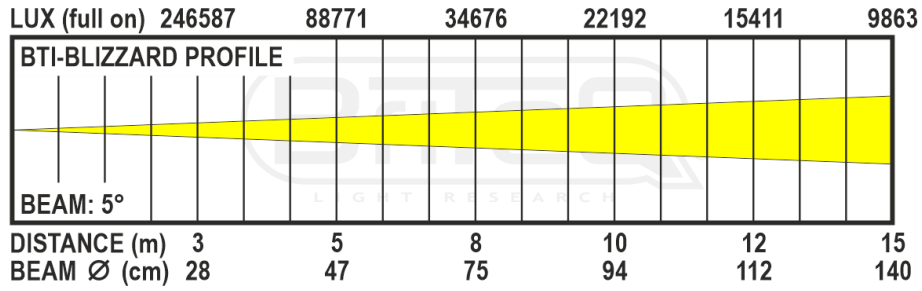

### COLOR WHEEL

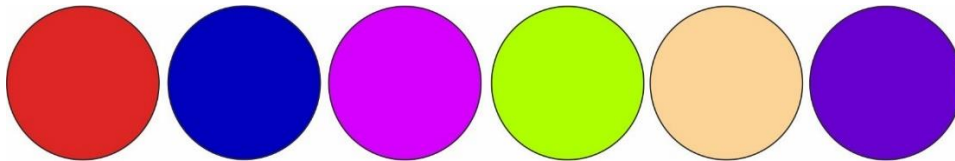

### ROTATING GOBOS

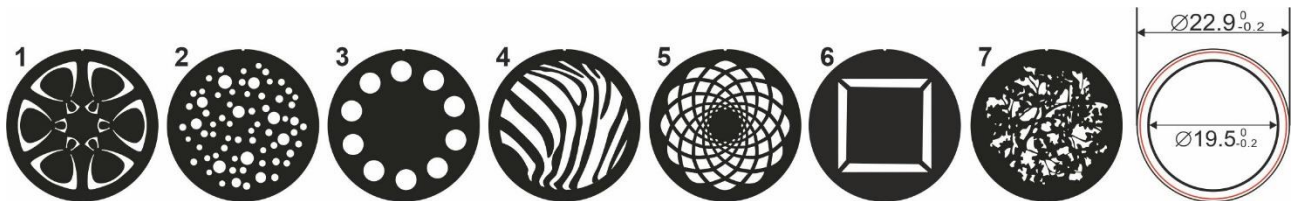

### STATIC GOBOS

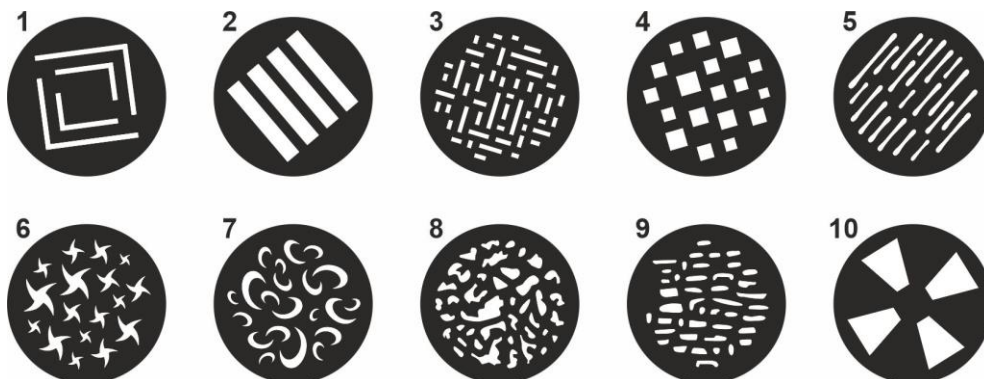

All the information is subject to change without prior notice  
 You can download the latest version of this user manual on our website: [www.briteq-lighting.com](http://www.briteq-lighting.com)





## MAILING LIST

**EN: Subscribe today to our mailing list for the latest product news!**

**FR: Inscrivez-vous à notre liste de distribution si vous souhaitez suivre l'actualité de nos produits!**

**NL: Abonneer je vandaag nog op onze mailinglijst en ontvang ons laatste product nieuws!**

**DE: Abonnieren Sie unseren Newsletter und erhalten Sie aktuelle Produktinformationen!**

**ES: Suscríbete hoy a nuestra lista de correo para recibir las últimas noticias!**

**PT: Inscreva-se hoje na nossa mailing list para estar a par das últimas notícias!**

**[WWW.BRITEQ-LIGHTING.COM](http://WWW.BRITEQ-LIGHTING.COM)**

**Copyright © 2024 by BEGLEC NV**

't Hofveld 2C ~ B1702 Groot-Bijgaarden ~ Belgium

Reproduction or publication of the content in any manner, without express permission of the publisher, is prohibited.